

REV.	ECN NO.	DESCRIPTION	DESIGN	DATE
A		INITIAL	Kai	2018.03.29

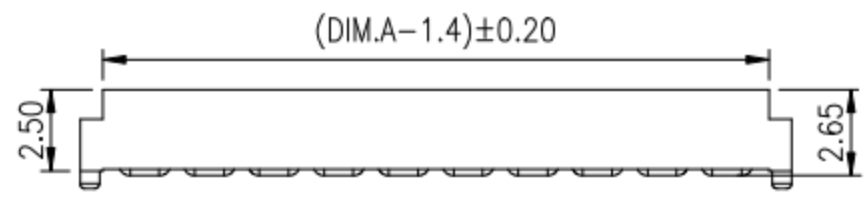

PIN	Dim. A	Dim. B	Dim. C
02pin	6.00	2.00	5.40
03pin	8.00	4.00	7.40
04pin	10.00	6.00	9.40
05pin	12.00	8.00	11.40
06pin	14.00	10.00	13.40
07pin	16.00	12.00	15.40
08pin	18.00	14.00	17.40
09pin	20.00	16.00	19.40
10pin	22.00	18.00	21.40

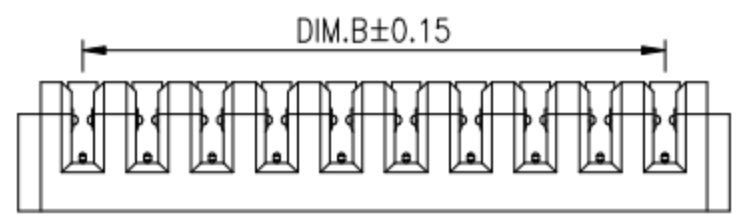
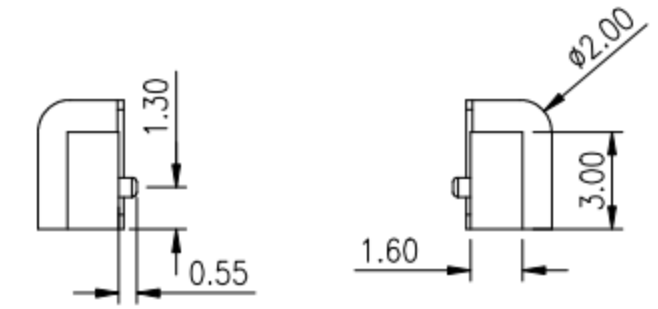
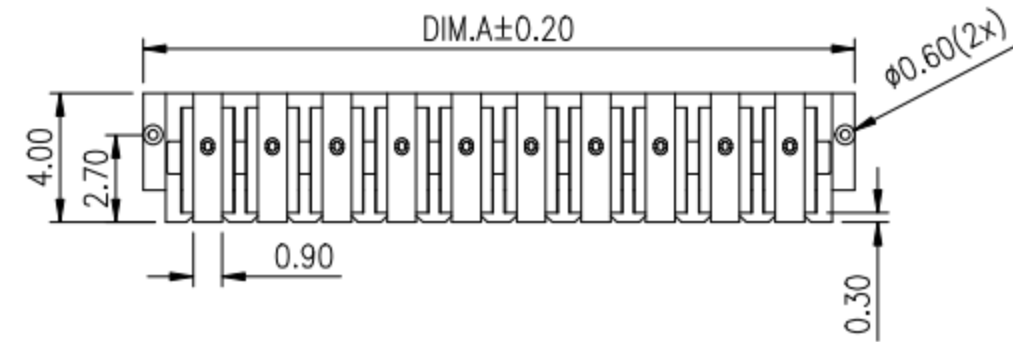
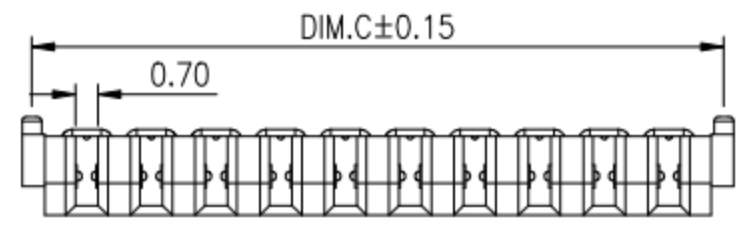
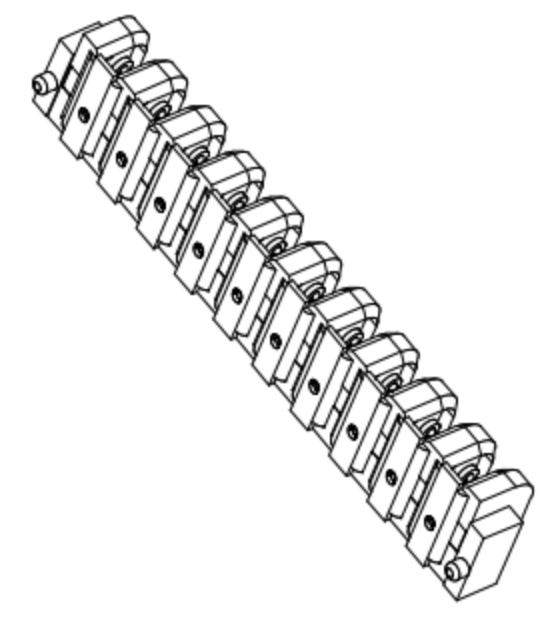

NOTE:  
 Material  
 Insulator:Nylon 9T(UL94V-0)  
 Contact:phosphor Bronze  
 Contact Plated:Gold over Nickel or Tin  
 Specification  
 Rated voltage: 12V 30V  
 Current rating: 3A 5A  
 instant CURRENT:7A  
 Contact Resistance:30MΩ  
 Insulation Resistance:100MΩ  
 Dielectric Voltage:1000V  
 Operdting Temperature:-40°~105°

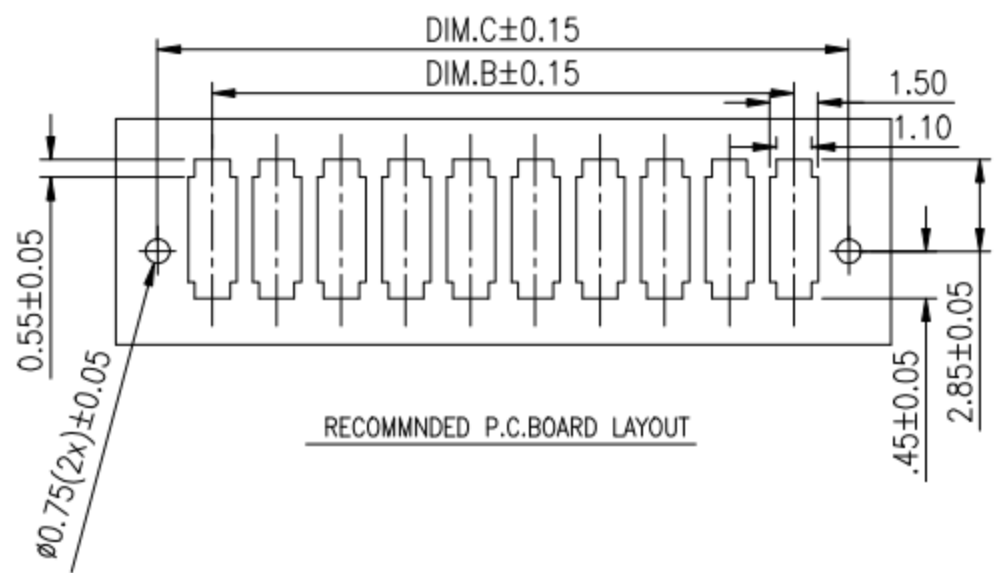

UNLESS OTHERWISE SPECIFIED TOLERANCES

DECIMALS:		ANGLES:	
DIM	TOL	DIM	TOL
X.	±0.50	X.	±2°
X.X	±0.30	X.X	±1°
X.XX	±0.20	X.XX	
X.XXX	±0.10	X.XXX	

东莞市高迪电子有限公司

ITEM	PART NAME	Q'TY	MATERTAL	DESCRIPTION	REMARK
②	HOUSING	1	LCP		BLACK
①	CONTACT A	2	PHOSPHOR BRONZE 0.20T	Au PLATED	

DWG NO.	PART NAME:
DESIGN:	PART NO.
CHECK:	REV. A
APPROVED	UNIT: mm
	SHEET: 1/1